

T-DRILL

T-60



Instruction Manual
Spare Parts List

Version

3305-10-03

04.12.2002 LK

26.1.2004 /LK

Instruction Manual

This instruction manual includes a spare parts list and instructions for set-up for operation, operation and maintenance of the **T-DRILL T-60 tee forming machine**. Type code of manual is 3305-10-03

Manufacturer:

**Subsidiary: Covering North
America**

T-DRILL OY
P.O BOX 20
FIN-66401 Laihia, Finland
Tel. Int +358-6-4753 333
Telefax: (G3) +358-6-4753 300
www.t-drill.fi

T-DRILL
INDUSTRIES INC.
1740 Corporate Drive, Suite 820,
Norcross, Georgia 30093, USA
Phone: 800-554-2730
Fax: 770-925-3912
www.t-drill.com

Your local **T-DRILL** representative is:

Copyright © 2002 T-DRILL Oy. All rights reserved. This manual, or parts thereof, may not be reproduced in any form or by any means, nor translated into any other language without a written permission of T-DRILL Oy.

This manual has been produced with a great deal of care and attention. All information has been checked for accuracy. No liability will be accepted for any incorrect or incomplete information.

Table of contents

1. Notes on the use of the instruction manual	5
1.1 Symbols for warning used in this manual	5
1.2 Symbolism	6
2. General safety instructions	7
2.1 General safety instructions for work area	7
2.2 Safety instructions for tool	8
2.3. Safety instructions for tee forming	10
3. T-DRILL T-60, general	11
3.1 Introduction	11
3.2 The Parts of the T-60	11
3.3 Information about Accessories	12
3.4 Operating Range of the Machine	13
3.5 Technical specifications	13
4. Transport, Handling and Storage	14
4.1 T-60	14
5. Preparing before use	15
5.1 T-60, Detachment and attachment of the connecting cord	15
5.2 T-60:s start-up check	15
6. The operation of the machine	16
6.1 Description of the control devices	16
6.2 Selection and adjustment of the T-DRILL heads	18
6.3 Chucking the T-DRILL head	21
6.4 The tee forming process with the T-DRILL T-60	23
6.5 Annealing of tube	26
7. Maintenance	28
7.1 The maintenance of the T-DRILL T-60	28
7.2 The replacement of the forming pins	29
8. Trouble-shooting.....	30
9. Disposing.....	32
10. Warranty.....	33
11. Supplement.....	34
12. Spare parts list	38
12.1. T-60	38
12.2. The T-60 Tee Forming Unit	40
12.3 T-DRILL Head.....	42
12.4 Counterplate	43
12.5 Optional Equipment	43
13. Ordering spare parts.....	45

1. Notes on the use of the instruction manual

1.1 Symbols for warning used in this manual

IMPORTANT! Gray base color is used to emphasize an important detail



NOTE! May cause an accident or damage other property, if the right precautionary measures have not been taken.



DANGER! Will or may cause a serious accident or death, if the right precautionary measures have not been taken.

This instruction manual includes instructions for set-up, operation and maintenance of the **T-DRILL T-60 tee forming machine**. This book also includes instructions on how to use and select T-DRILL heads for hand tools.



NOTE! Before carrying out any actions, read chapter 2 "Safety Instructions".

Get acquainted with the instruction manuals of the MILWAUKEE DRILL delivered with the machine before using the T-60 machine.

Acquaint yourself with the machine before using it. Read the operation sequence described in the instruction manual thoroughly before preparing, operating or maintenance of the machine.

IMPORTANT! Save these instructions for future use!

1.2 Symbolism

The following list defines the symbols on the tool.



Read the instruction manual carefully before using this tool.

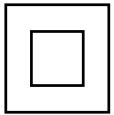

Double Insulated

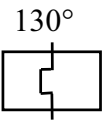

Thermally protected to 130°C)



Warning! Do not throw to trash. Please recycle

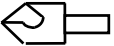

Warning! Watch your fingers. Rotating tool.

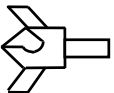

2. General safety instructions

Read all the instructions before using the machine.

Know your power tool - Read the instruction manual carefully. Learn to know your own skill and limitations as well as the specific potential hazards peculiar to this tool.



DANGER! - The use of any accessory or attachment other than the ones recommended in this operating instruction or T-DRILL catalogue may create a risk of personal injury.



NOTE! **Never detach the MILWAUKEE power unit** from the T-DRILL tee forming unit. Detaching the power unit will damage the alignment made in factory.

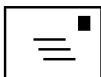

NOTE! - The T-DRILL T-60 is designed for use with MILWAUKEE power unit. **Using any other power units** with the T-DRILL T-60 tee forming unit **is not allowed.**

IMPORTANT! Warranty is void if the power unit is detached from the tee forming unit!

2.1 General safety instructions for work area

Keep work area clean – Cluttered areas and benches invite injuries.

Consider work area environment – Don't use power tool in humid or wet conditions. Keep work area well illuminated. Don't use power tool in the presence of flammable liquids or gases.

Keep children away – Do not let visitors touch the tool or it's extension cord. All visitors should be kept away from work area.

Stay alert – Be aware of what you are doing. Use common sense. Do not operate tool when you are tired.

2.2 Safety instructions for tool

Store idle tools – when not in use, tools should be stored in dry, high, or locked-up place, out of the reach of children.

Don't force tool – It will do the job better and safer at the rate for which it is intended.

Dress properly – Do not wear loose clothing or jewelry. They can be caught in moving parts. Use appropriate gloves and footwear. Wear protective hair covering to contain long hair.

Use safety glasses – Also use face or dust mask if cutting operation is dusty.

Secure work – Use clamps or a vise to hold your work piece. It's safer than using your hand and it frees both hands to operate the tool.

Don't overreach – Keep proper footing and balance at all times.

Maintain tools with care – Keep tools sharp and clean for better and safer performance. Follow instructions for lubricating and changing accessories. Inspect tool cords periodically and, if damaged, have them repaired by authorised service workshop. Inspect extension cords periodically and replace if damaged. Keep handles dry, clean and free from oil and grease.

Don't abuse cord – Never carry a tool by its cord or yank it to disconnect it from receptacle. Keep cord from heat, oil and sharp edges.

Disconnect tools – When not in use, before servicing, and when changing accessories such as blades, bits and cutters.

Remove adjusting keys and wrenches – Make it a rule to check that keys and adjusting wrenches are removed from tool before turning it on.

Avoid accidental starting – Do not use a tool if the power switch does not turn the tool on and off. Do not carry the tool with your finger on the switch.

Outdoor use extension cords – When tool is used outdoors, use only extension cords intended for use outdoors and so marked.

Check damaged parts – Before further use of tool, a guard or other part that is damaged should be carefully checked to determinate that it will operate properly and perform its intended function. Check for alignment of

moving parts, binding of moving parts, breakage of parts, mounting, and any other conditions that may affect its operation. A guard or other part that is damaged should be properly repaired or replaced by an authorised service unless otherwise indicated elsewhere in this instruction manual. Have defective switches replaced by an authorised service. Do not use tool if switch will not turn it on and off.

Have your tool repaired only by T-DRILL – This electric tool is in accordance with the relevant safety requirements. Repairs should be carried out only by certified persons using original spare parts; otherwise, this may result in considerable danger to the user.

Keep tools away from items that may be damaged by magnets – The motor contains a powerful magnet that may damage magnetic tape, credit cards, computer disks and watches.

Use ear protectors. During operation the noise level of the collaring machine may exceed 95dB(A).

The vibration exercised on the operator's hand is less than 2.5m/s.

2.3. Safety instructions for tee forming

Do not touch the rotating tool when the work cycle is on.

When fixing the machine to the tube, be careful not to leave your fingers between the machine and the tube

When handling the tools, be careful with the cutting blades. Use protective gloves.

A falling machine or tool may damage your feet. Use protective shoes.

The lubricating oil you use may cause irritation of the skin. Use protective gloves.

The fumes emitted by the lubricant may irritate your eyes and hinder your respiration. Pay attention to an adequate ventilation.

Make yourself familiar with the contents of the safety data sheet regarding the lubricants.

The loosening chips are hot and sharp. Provide adequate protection in order not to get damaged.

Be careful to avoid accidental starting of the machine when handling it. Never carry the tool with your finger on the trigger.

When cleaning the collar always use protecting gloves. The edges of the collar use to be sharp.

Do not use inadequate protecting gloves, because they may get caught by the rotating tool. Keep your hands off the dangerous area.

3. T-DRILL T-60, general

3.1 Introduction

The **T-DRILL T-60** is a special tool intended for mechanically forming tees in copper tube typically found in domestic, commercial and industrial tubing systems. The T-60 extrudes in the run tube an outlet, to which the branch tube can be joined by brazing.

Before attempting to put the T-60 into service, make sure you have read and fully understood the safety instructions which apply to all power tools and capabilities of this special tool.

The **T-DRILL T-60** includes an electric network driven power unit with accessories. The power unit is grounded 120V /60Hz or double insulated 110V /50Hz and 230V /50Hz.

3.2 The Parts of the T-60

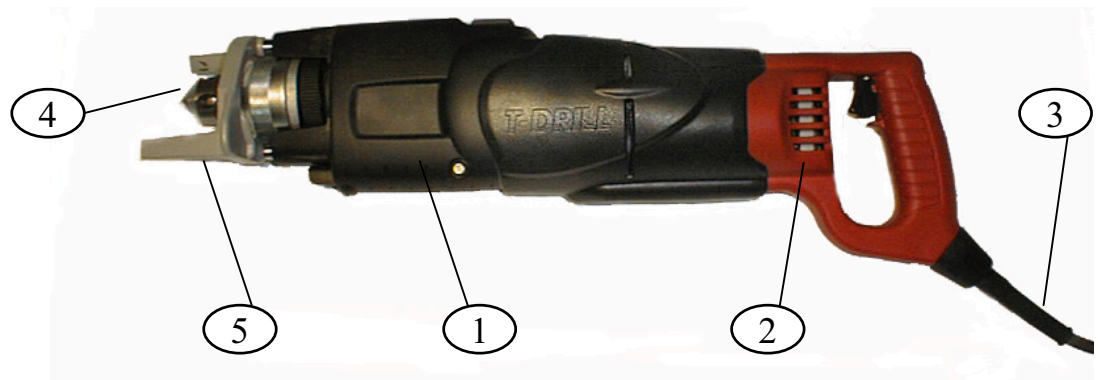

Main parts: 1. T-DRILL tee forming unit, 2. Power unit, 3. Connecting cord, 4. T-DRILL head, 5. Tube support.

3.3 Information about Accessories

For proper use of T-DRILL T-60 the following accessories are available:

Notcher ND-54

Tube end notcher forms the end of branch pipe to match inner curve of the run tube. In this way maximum flow is achieved. The notcher also presses two dimples simultaneously in the end of the branch tube, one acting as a depth stop and the other one for inspection of the joint after brazing.

Gauge Block and rings

Correct size settings of the T-DRILL head for various tube sizes can easily be checked with the gauge block. The range of size is NS 1/4"-1" with the gauge block; 1 1/4", 1 1/2" and 2" with the rings).

Counter Plate

The counter plate assists forming of the outlet and improves the quality of the outlet by supporting the tee forming machine against the run tube. The counter plate is used for run tube sizes from NS 2 1/2" (66.7 mm) to 4" (108 mm).

Lubrication for copper

A bottle of lubricant to be used for forming the outlet in copper tube, is included.

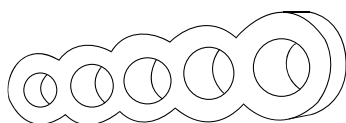

3.4 Operating Range of the Machine

The T-DRILL T-60 is intended for forming a tee in copper tube. The branch tube is joined to the run tube by brazing.

The outlet size range of T-60 is NS 1/2" to 2" (10 – 54 mm).

The diameter of the run tube can be 1/2 " to 4" (15 – 108 mm). The maximum wall thickness of the tube to be branched depends on the tube diameter and the size of the T-DRILL head used.

Accurate capacity values: diameters and wall thicknesses of the tube are specified in the capacity chart (chapter 11.1).

3.5 Technical specifications

T-60	Value	NOTE!
Type Code	3305	
Tee diameter	NS 1/2" - 2" / 10– 54mm	
Run tube	NS 1/2" - 4" / 15– 108mm	
Max. wall-thickness	See Capacity chart (11.1)	
Materials	Copper (Cu)	
Cycle	1 min. 45 s	
Rotation speed of spindle	500 / 50 RPM	
A-accentuated equivalent level of sound pressure	82,5 dB (A)	Use ear protectors!
Vibration	less than 2,5 m/s ²	
Dimensions of the unit	22.4"(l) x 4.9" (h) x 7.1" (d) 570 (l) x 125 (h) x 180 (d) mm	
Weight of the unit	11,9 lbs /5,4 kg	
Supply voltage of the unit	120V / 60Hz / 7,0AMPS 230V / 50Hz / 4,0A 110V /50Hz 8,4AMPS	

4. Transport, Handling and Storage

4.1 T-60

The **T-60** is delivered in a transport box, dimensions 25.2" (640mm) x 6.5" (165mm) x 14.2" (360mm) (w x h x d). The weight of the box is, depending on the accessories, between 29 - 49 lbs (13 and 23 kg) .

Storage

Keep the T-60 stored in a cool, dry place, covered against dust etc.

5. Preparing before use

5.1 T-60, Detachment and attachment of the connecting cord

When delivered the T-60 power unit is fitted with a connecting cord, which allows quick changing in field conditions.



Detachment of the cord

Turn the nut of the cord 1/2 turn to the left in order to loosen the cord.
Draw the cord out of the power unit.

Attachment of the cord

Push the connector of the cord into the socket of the power unit, pushing the connector as far as it will go.
In order to lock the cord, turn the nut 1/2 turn to the right.

5.2 T-60:s start-up check



NOTE! Carry out the start-up checks before using the machine.

Before using the machine, proceed as follows:

1. Check that the cord is connected to the machine
2. Check that the cord is connected to the mains.

6. The operation of the machine

6.1 Description of the control devices

6.1.1 T-DRILL T-60

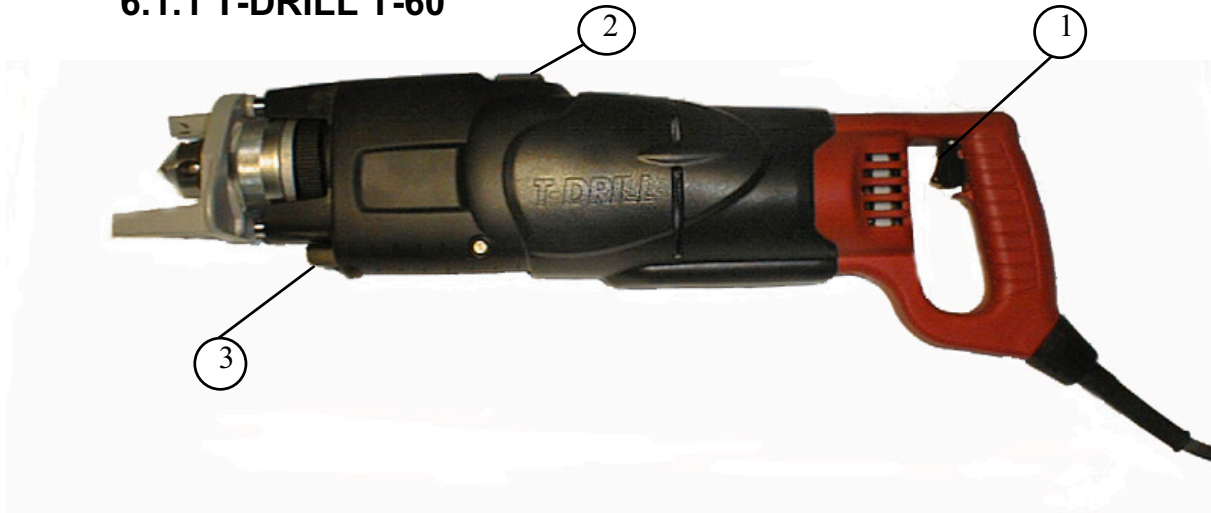

Control devices: 1. Trigger, 2. Speed selector 3. Feed mechanism engagement lever

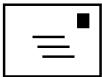

NOTE! Use maximum speed of rotation when drilling and forming the outlet - **when working press the trigger completely down!**

1. Speed selector

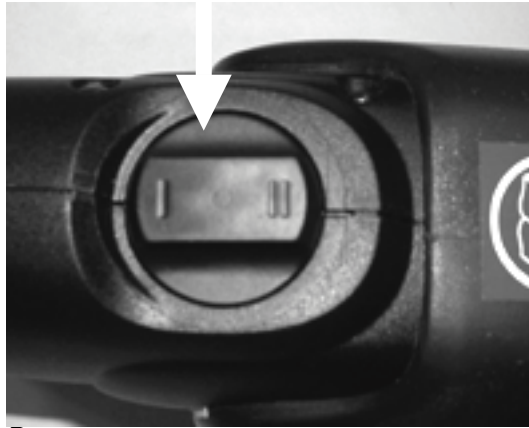

2. The feed mechanism lever

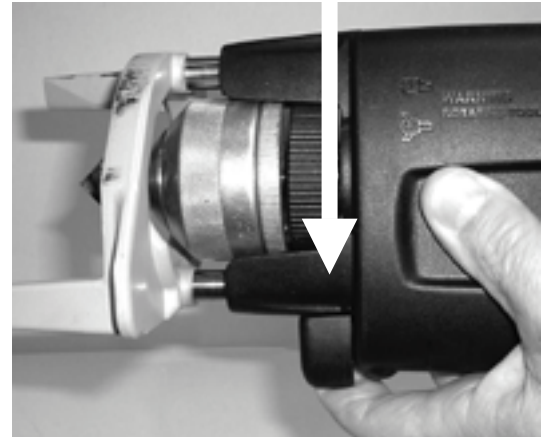

The speed selector knob is on the top of the gearbox of the T-60. Slow speed is marked “I” and fast speed is marked “II”. To shift from fast to slow speed, turn the selector knob 180 degrees. Drilling is always done in fast speed (II). The forming of the tee is done in either slow speed or fast speed depending on the run tube and outlet sizes. See the chart in chapter 11.

If the speed selector knob does not engage smoothly, rotate the motor by “bumping” the trigger.

The feed mechanism lever is situated near the chuck-ring. The feed mechanism is engaged (on) when the lever is turned downward, i.e. as shown on the illustration.

If the feed mechanism lever does not engage smoothly, rotate the motor by “bumping” the trigger.

Do not force lever.

6.2 Selection and adjustment of the T-DRILL heads

6.2.1 The identification of the T-DRILL head

The size of the T-DRILL head is stamped on the cover plate:

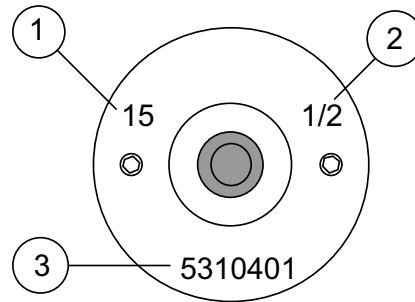

Identification: 1. Actual size in millimetres, 2. Nominal size in inches (NS),
3. The ordering and identification number of the T-DRILL head

6.2.2 The fine adjustment of the outlet diameter



NOTE! When adjusting the outlet diameter, extend the forming pins first.

Each T-DRILL head is adjusted at the factory to correspond to the nominal size stamped on the cover of each T-DRILL head. Changing the tube sizes or the way of joining may require adjustment of the T-DRILL head in order to achieve the right joint.

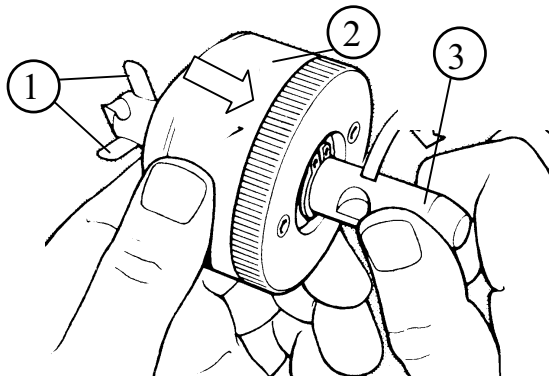

To extend the forming pins (1) press the cover (2) in direction of the shank. Twist the shank (3) at the same time clockwise until a positive stop is reached, and the forming pins extend.

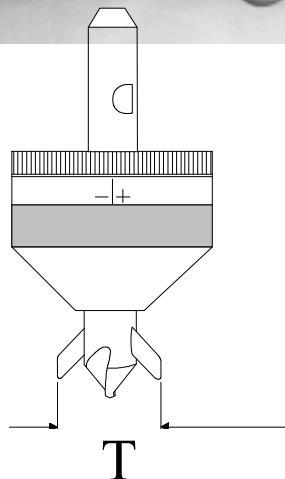
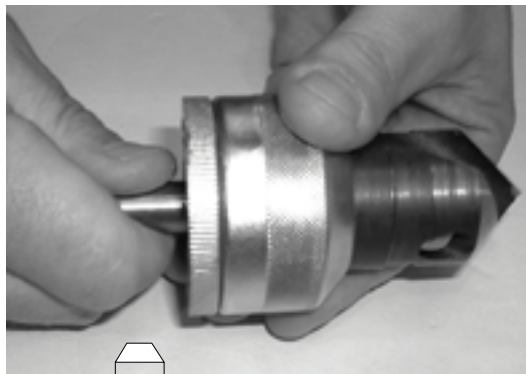

Check the forming pin span diameter T with an adjusting ring or slide gage.

Depending on the size of the T-DRILL head, the forming pin span T should be 0,020" – 0,055" (0,5 – 1,4mm) bigger than the branch pipe outer diameter (O.D.)

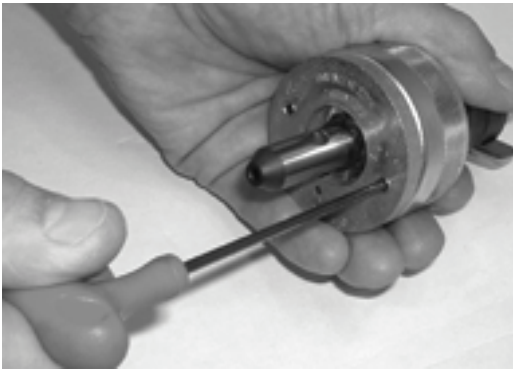

1. Loosen the screws on the cover plate by about one circle using a 3 mm hexagon wrench, that is supplied with the T-DRILL package.

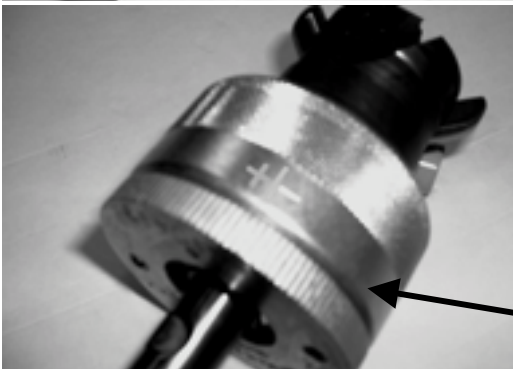

2. To enlarge the outlet rotate **the conical cover** with respect to the cover plate in plus (+) direction. Hold the cover plate stationary.

To make a smaller outlet **rotate the conical cover** in minus (-) direction while holding the cover plate stationary.

**One
note**

h on the cover-plate equals to 0.01" or 0,25 mm on the forming pin span.



3. Tighten the two screws on the cover plate and check the adjustment either by measurement across the pins or by forming a trial outlet.

6.3 Chucking the T-DRILL head

6.3.1 Chucking

To insert the T-DRILL head into the chuck, rotate the locking ring (1) clockwise and slide the T-DRILL head shaft into the chuck (2). Release the locking ring. Rotate the T-DRILL head (3) in the chuck until it locks. Make sure the T-DRILL head is tightly chucked.

6.3.2 Removal

To remove the T-DRILL head (2) from the chuck (1), rotate the locking ring as far it will go. Turn the T-DRILL head to the same direction one quarter of a turn ($1/4$) at the same time pulling it straight out. Release the lock ring.

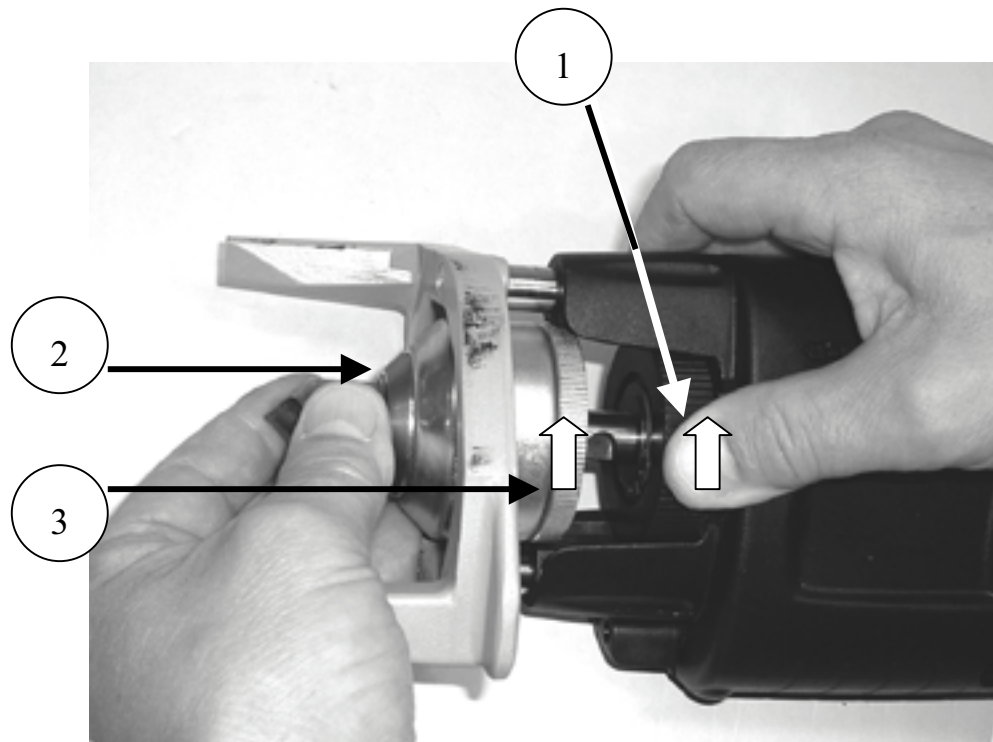

Chucking the T-DRILL head and removing it.

6.3.3 Fitting the old T-DRILL heads to the T-60 –machine

If you have old 42/1½ or 54 /2 T-DRILL heads, you can use them in T-DRILL T-60 after shortening the drill core as described below. Without shortening the drill cores of old T-DRILL heads do not fit in the chuck of the T-60.

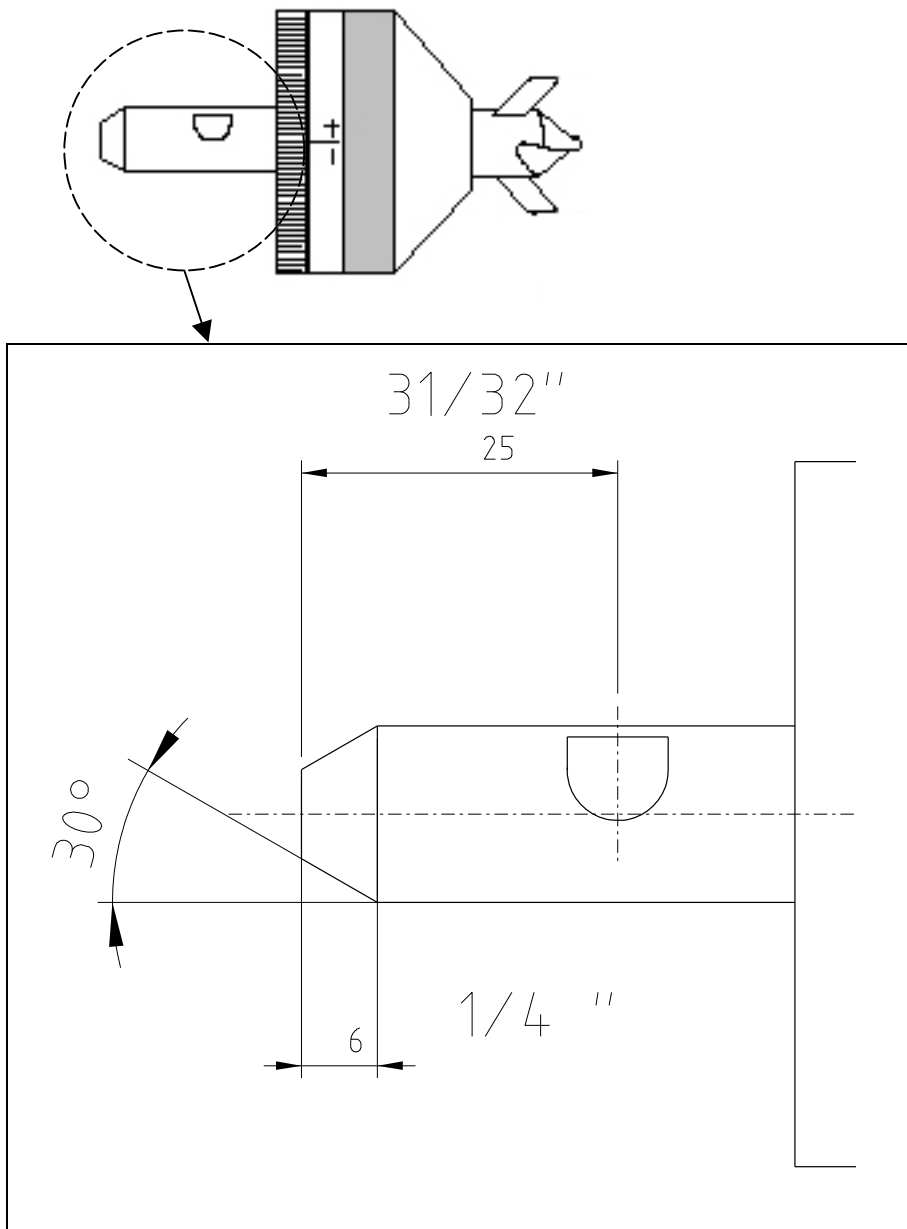

6.3.3 Shortening the drill core. The distance between the center line of the draft hole and the core end has to be $31/32''$ (25 mm).

6.4 The tee forming process with the T-DRILL T-60

Since the process may be new to you, we recommend that you read the following instructions carefully and then practice a few times on some pieces of scrap tubing.



NOTE! Before forming any tee always make sure that the pipe is completely drained and that it is not under pressure

1. Select the correct T-DRILL head.
2. Check the forming pin span (T). Adjust if necessary. (See chapter 6.2.2).
3. Chuck the T-DRILL head.



4. **Lubricate the T-DRILL head** before every tee forming operation! Extend the forming pins and lubricate them as well as the cutting edges of the T-DRILL head as illustrated. **Always use T-DRILL lubricant.**

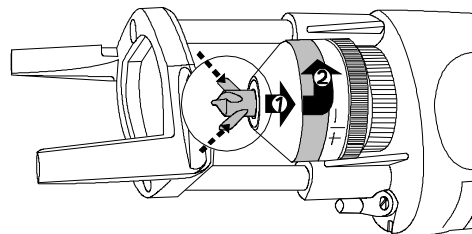

5. **Retract forming pins.** Press the conical cover towards the tool and rotate it clockwise to retract the forming pins.

6. Check that the **speed selector knob** is in position **II** and the **feed mechanism lever** in “off”-position.

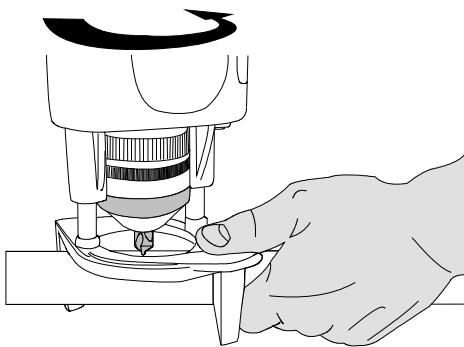
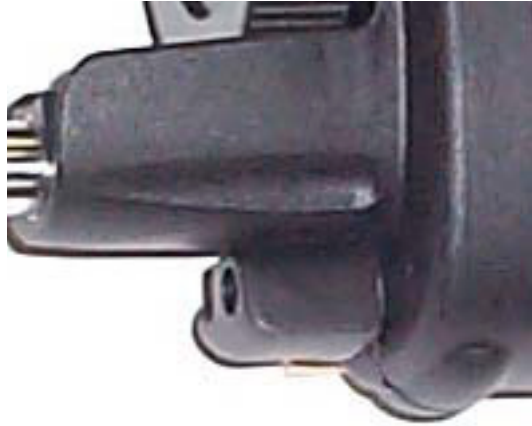

7. Pull the **support legs out** and place the tube support firmly onto the point where the tee is to be formed on the tube, as shown on the illustration. Press the tube support with the thumb against the tube and **twist** the machine **counterclockwise** at the handle of the tool. This **centers** the T-DRILL head onto the tube.

8. Start the tool by pressing the trigger and **drill** until the bit has fully penetrated into the tube. Release the trigger - the machine will stop.

NOTE! If the tool does not have enough power to drill – select the low speed **I** and continue drilling. This may be necessary if a long extension cord is used.

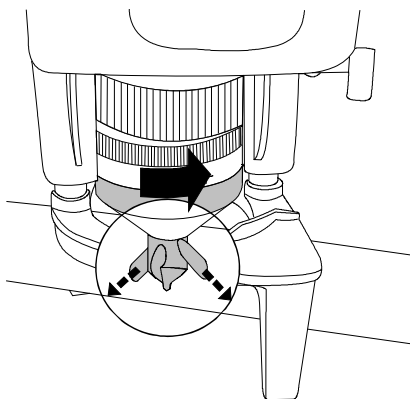

9. **Extend the forming pins** on the T-DRILL head by pressing the conical cover towards the tool and rotating it counterclockwise until the T-DRILL head locks into the tee forming position. **Do not extend the forming pins while the motor is running!**

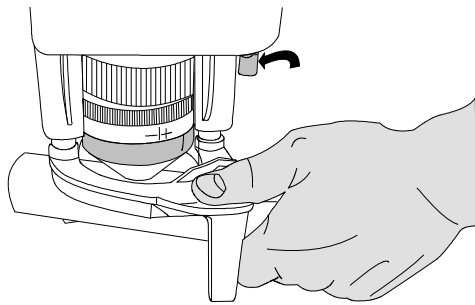

10. Select low speed **I** by turning the selector knob. (Always use low speed (**I**) when forming the outlet, consult capacity chart in section 11.1 for options.) **Engage the feed mechanism** as shown. If it does not engage smoothly, rotate the motor by “bumping” the trigger.

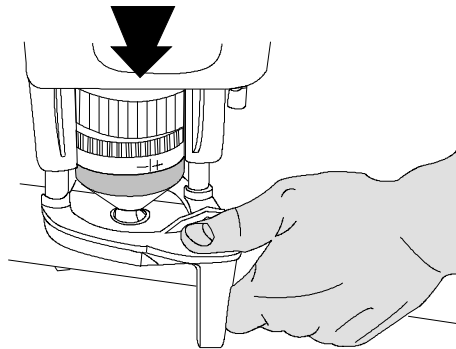

11. Start **forming the outlet** by pulling the trigger and continue until the T-DRILL head is completely out of the tube. During the forming of the tee, keep the tube support against the tube and push the tool toward the tube. This insures that you obtain a circular outlet.

12. Once the T-DRILL head has come **completely out** of the outlet, release the trigger.

IMPORTANT! Release the drill trigger as soon as the T-DRILL head clears the rim of the outlet.

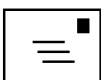

NOTE! Never attempt to “help” the tool by pulling it out of the tube. This would result in an oval outlet!

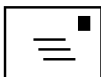

NOTE! Wipe away any excess lubricant which may have remained inside the outlet before brazing. **Use sandcloth or Scotchbrite to clean the inside of the rim of the outlet!**

6.5 Annealing of tube



DANGER! The annealed work piece is extremely hot after annealing. When working with the tube protective gloves should be used.

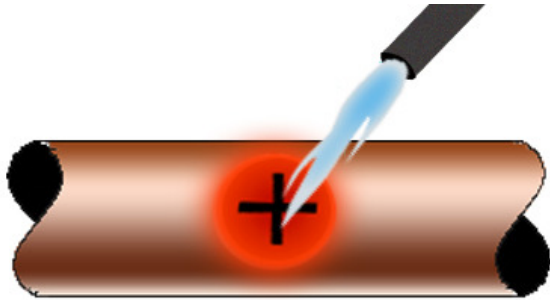

1. Anneal the area where outlet is to be formed to a dull red. The area will remain annealed even when cool. It is not necessary to form the outlet on hot tube!



2. Attach counterplate to the tube where annealing has been done.



3. Lubricate forming pins and cutting edges on T-DRILL head.

T-60

TEE FORMING MACHINE



4. Retract forming pins on T-DRILL Head and attach T-DRILL T-60 to counterplate. Notches on tube support fit on tabs of counterplate.



5. Drill pilot hole, extend forming pins, reduce speed, engage feed mechanism, pull trigger to form the outlet. Release trigger when forming pins clear the rim of the outlet.



6. Notch and dimple both sides of branch tube.

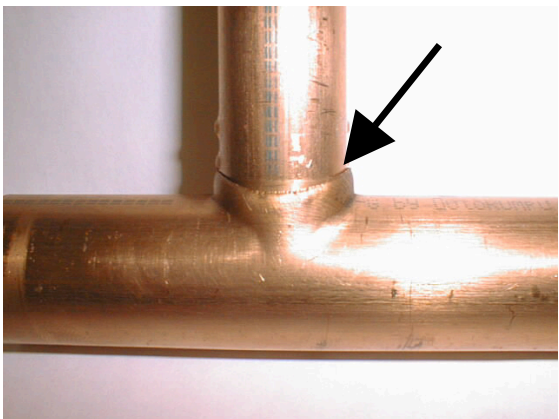

7. Align dimples with the run of the tube after insertion into the outlet. Braze the joint.

7. Maintenance

7.1 The maintenance of the T-DRILL T-60

The T-DRILL T-60 is prelubricated and does not need special attention for maintenance. Clean dust and dirt from tool vents.



NOTE! All maintenance operations for the T-DRILL T-60 and MILWAUKEE power unit sold in North America are to be carried out only by T-DRILL Industries, Inc. in Norcross, Georgia, USA.

7.2 The replacement of the forming pins

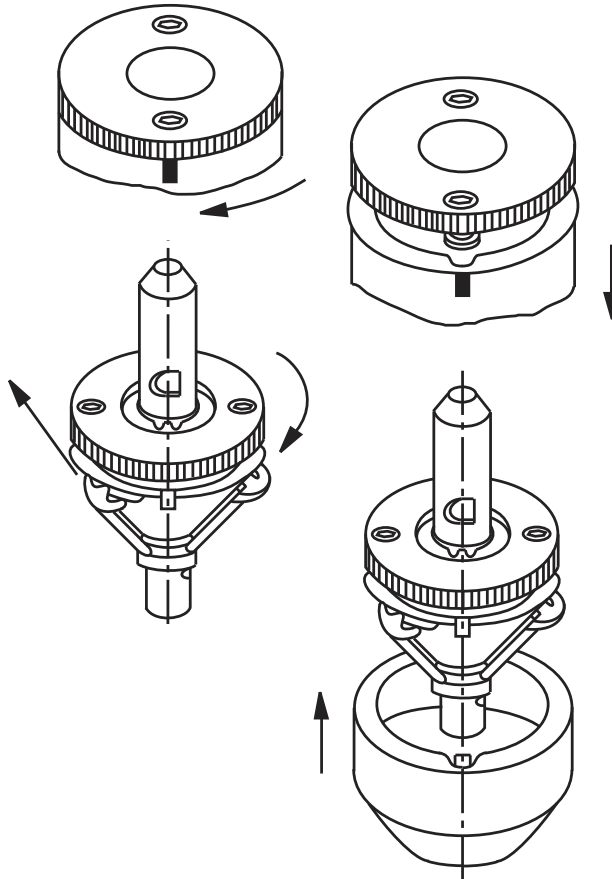

1. Loosen the **two screws on the cover plate** one turn and rotate the conical cover with respect to the cover plate so that the conical cover can be removed. When the conical cover is removed rotate the cone so that the forming pins will slide from the shank.

2. The forming pins can now be changed.

3. Reassemble the T-DRILL head using new forming pins and **adjust** to the right outlet diameter.

8. Trouble-shooting

Problem	Cause	Remedy
The power unit doesn't run.	The connection cord loose, or the plugs do not make contact with the wires inside the cord. Trigger not fully pressed.	Insert the cord into the bracket, or substitute the cord with a new one. Press the Trigger fully.
Burrs in the tee that has been formed	Burrs in the pilot hole - the drill bit is dull - lubricant insufficient - lubricant of bad quality The forming pins are worn or dirt stuck on their surface. Insufficient lubricant during forming of the outlet. Lubricant not suitable to the material The wall thickness of the tube exceeds the maximum allowable thickness.	- Anneal Area to be drilled - Change drill bit - Use more lubricant - Only lubricant recommended by T-DRILL is to be used Clean or change the forming pins Always lubricate the T-DRILL head carefully before every outlet forming operation Consult your local T-DRILL representative Consult the capacity charts
The size of the tee varies.	Dirt stuck to the surface or the holes of the forming pins. Adjusting screws of the head are too loose.	Clean the forming pins. Tighten the screws

Problem	Cause	Remedy
<p>The forming pins break off or the drill shank breaks</p>	<p>Lack of annealing when called for in instructions. Burrs in the pilot hole -drill bit dull</p>	<p>– Resharpen or change the drill bit</p>
	<p>The wall-thickness of the tube exceeds the max. allowable thickness.</p>	<p>See the capacity charts.</p>
	<p>Not enough lubricant during forming of the tee.</p>	<p>Lubricate the T-DRILL head carefully before forming the outlet.</p>
	<p>The lubricant is not suitable for your material</p>	<p>Consult your local T-DRILL representative.</p>
	<p>Tool is not straight against the pipe.</p>	<p>Use counterplate. (extra equipment)</p>
	<p>Slow speed was not used when referenced on the capacity chart.</p>	<p>Use slow speed when indicated on the capacity chart.</p>

9. Disposing

Disposing of the T-DRILL machine

In the manufacturing of the T-DRILL machines various kinds of metals, plastic and lubricants have been used. Dispose of your T-DRILL machine according to federal, state and local regulations.

10. Warranty

T-DRILL guarantees that every T-DRILL T-60 tee forming machine is free from defects in materials and workmanship (other than normal wear and tear) for a period of one (1) year from date of shipment. Should within this period any T-60 be proved to **T-DRILL's** satisfaction to be defective, such product shall be repaired or replaced. Such repair or replacement shall be **T-DRILL's** sole obligation; whereas the buyer's only obligation is to inform **T-DRILL** of any such defect. **T-DRILL** must receive the reclamation in writing within 10 days after a defect having been noticed and, at **T-DRILL's** option, buyer will have to return the complete tool to the nearest **T-DRILL** Representative or Distribution Center. **THIS WARRANTY IS PRIMARY.**

T-DRILL's warranty shall be limited to the aforesaid warranty stipulations. **T-DRILL** SHALL NOT BE SUBJECT TO ANY OTHER OBLIGATIONS OR LIABILITIES, WHETHER ARISING OUT OF BREACH OF CONTRACT, TORT (INCLUDING NEGLIGENCE) OR OTHER THEORIES OF LAW, WITH RESPECT TO PRODUCTS SOLD OR SERVICES IMPLICATED, OR ANY UNDERTAKINGS, ACTS OR OMISSIONS RELATING THERETO. **T-DRILL** SHALL NOT BE LIABLE FOR AND DISCLAIMS ALL CONSEQUENTIAL, INCIDENTAL AND CONTIGENT DAMAGES WHATSOEVER.

Please register your purchase by filling out and returning the warranty registration card enclosed. Save your receipt.

11. Supplement

Capacity and instruction chart for T-DRILL T-60 on M, L, & K tubing

Run Tube Size	1/2"	3/4"	1"	1-1/4"	1-1/2"	2"	2-1/2"	3"	4"
Nominal Outlet Size	Notch and dimple all branch tubes. Place dimples in line with the run of the tube. Braze all joints								
1/2"	3	1	1	1	1	1	5 4	5 4	5 4
3/4"		3	1	1	1	1	5 4	5 4	5 4
1"			3*	1*	1*	1*	5	5	5
1-1/4"				3	2	2	5	5	5
1-1/2"					3	2	5	5	5
2"						3	5	5	5

 = Pre-anneal the area where tee is to be formed or anneal pilot hole in this section. Form tee at slow speed. Use counter plate

* It may be necessary to use reduced speed to form the tee.

1. Apply T-DRILL lube to T-DRILL Head. Extend tube supports, place tube supports on either side of tube. Drill pilot hole, extend forming pins, engage feed mechanism, form outlet. Use high speed. Maintain pressure towards tube as outlet is formed.
2. After drilling pilot hole, extend forming pins, form outlet at reduced speed. maintain pressure towards tube as outlet is formed.
3. After drilling pilot hole, remove drill by engaging feed mechanism. Anneal briefly below each side of pilot hole. Reinsert drill, extend forming pins and form outlet. It may be necessary to slightly oversize forming pins to compensate for springback in copper tube wall. Maintain pressure towards tube as outlet is formed.
4. When a 1/2" or 3/4" outlet is needed on 2 1/2", 3" or 4" tube, follow the directions in Legend 5 **but** form a 1" outlet and reduce with fitting by copper reducer. Notch and dimple reducer. Align dimples with the run of the tube – braze joint.
5. Anneal to a dull red area where outlet will be formed. Attach counterplate to the tube. Apply T-DRILL lubricant to cutting edges and forming pins of the T-DRILL Head. Retract forming pins on T-DRILL Head and attach T-DRILL T-60 to the counterplate, drill pilot hole, extend the forming pins, reduce speed using the speed selector dial,

engage the feed mechanism, pull the trigger to form outlet. Notch and dimple branch tube. Insert branch tube into outlet, align dimples with the run of the tube – braze the joint.

** If motor slows during drilling of pilot hole, shift to slow speed.

NOTE: Lubricate drill bit and forming pins with T-DRILL lubrication on every outlet. After outlet is formed clean lubricant from inside edge of the rim with sand cloth or scotchbrite.

Have A Question?

Call Toll Free in USA 1-800-554-2730 Ext. 216

Capacity chart in millimeters

Use the capacity charts to determine the maximum wall-thickness of the tube and to select the right T-DRILL head.

Instructions for the use of the capacity charts:

1. Use the unit of measure that is correct for you: the measures of the charts are in both millimeters and in inches.
2. From the horizontal black row, find the tee size you need (inner diameter), and from the vertical black column the outer diameter of your run tube.
3. The intersection of the horizontal and vertical rows will show you the maximum wall-thickness of the tube. This thickness is not to be exceeded.

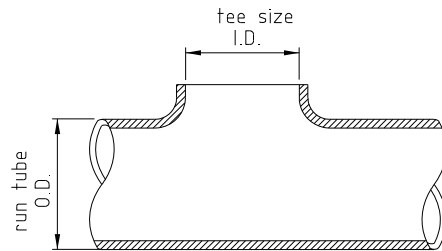

Capacity charts for forming tees in copper tubes

Max wall-thicknesses (mm)

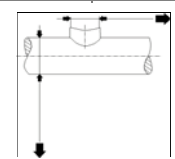
		10	12	15	18	22	28	35	42	54
		1/4"	3/8"	1/2"	5/8"	3/4"	1"	1 1/4"	1 1/2"	2"
10	1/2"	1.0	1.2	1.2						
18	5/8"	1.0	1.2	1.5	1.2					
22	3/4"	1.0	1.2	1.5	1.5	1.5				
28	1"	1.0	1.2	1.5	1.5	1.5	1.5			
35	1 1/4"	1.0	1.2	1.5	1.5	1.5	1.5	1.5		
42	1 1/2"	1.0	1.2	1.5	1.5	1.5	1.5	2.0	2.0	
54	2"	1.0	1.2	1.5	1.5	1.5	1.5	2.0	2.0	2.0
64	2 1/2"	1.0	1.2	1.5	1.5	1.5	1.5	2.5	2.5	2.5
76,1	3"	1.0	1.2	1.5	1.5	1.5	1.5	2.5	2.5	2.5
88,9	3 1/2"	1.0	1.2	1.5	1.5	1.5	1.5	2.5	2.5	2.5
108	4"	1.0	1.2	1.5	1.5	1.5	1.5	2.5	2.5	2.5

■ = Annealing before forming the tee is recommended!

12. Spare parts list

12.1. T-60

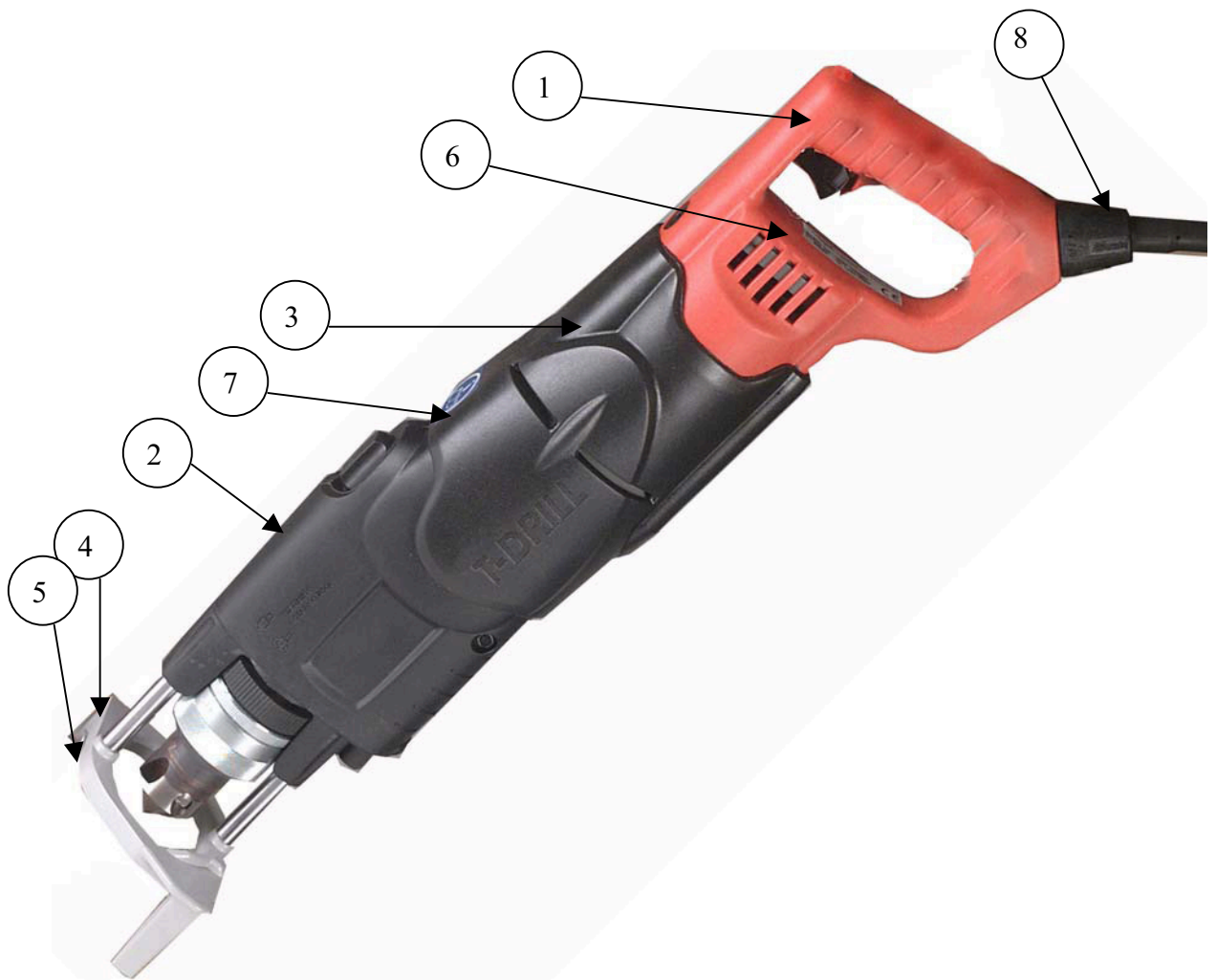

12.1. T-60

	Part No.	Complete Assembly	
	5330161	T-DRILL T-60 120V USA	
	5330163	T-DRILL T-60 230V Europe	
	5330110	T-DRILL T-60 110V UK	
	5330209	T-DRILL T-60 110V Japan	

Item	Part No.	Description	Qty
1	5330158 5330160 5330109	Power Unit 120V USA Power Unit 230V Europe Power Unit 110V UK /Japan	1
2	5330154	T-60 Tee Forming Unit	1
3	2330111	Adapter PUR	1
4	3330032	Tube Support	1
5	9114027	Socket head cap screw	2
6	4330164 4330165 4330108 4330223	Name plate 120V USA Name plate 230V Europe Name plate 110V UK Name plate 110V Japan	1
7	9146622	Sticker, read the instr.	1
8	9048335 9048320 9048342 9048331	Cord 120V USA Cord 230V Europe Cord 110V UK Cord 110V Japan	1

12.2. The T-60 Tee Forming Unit

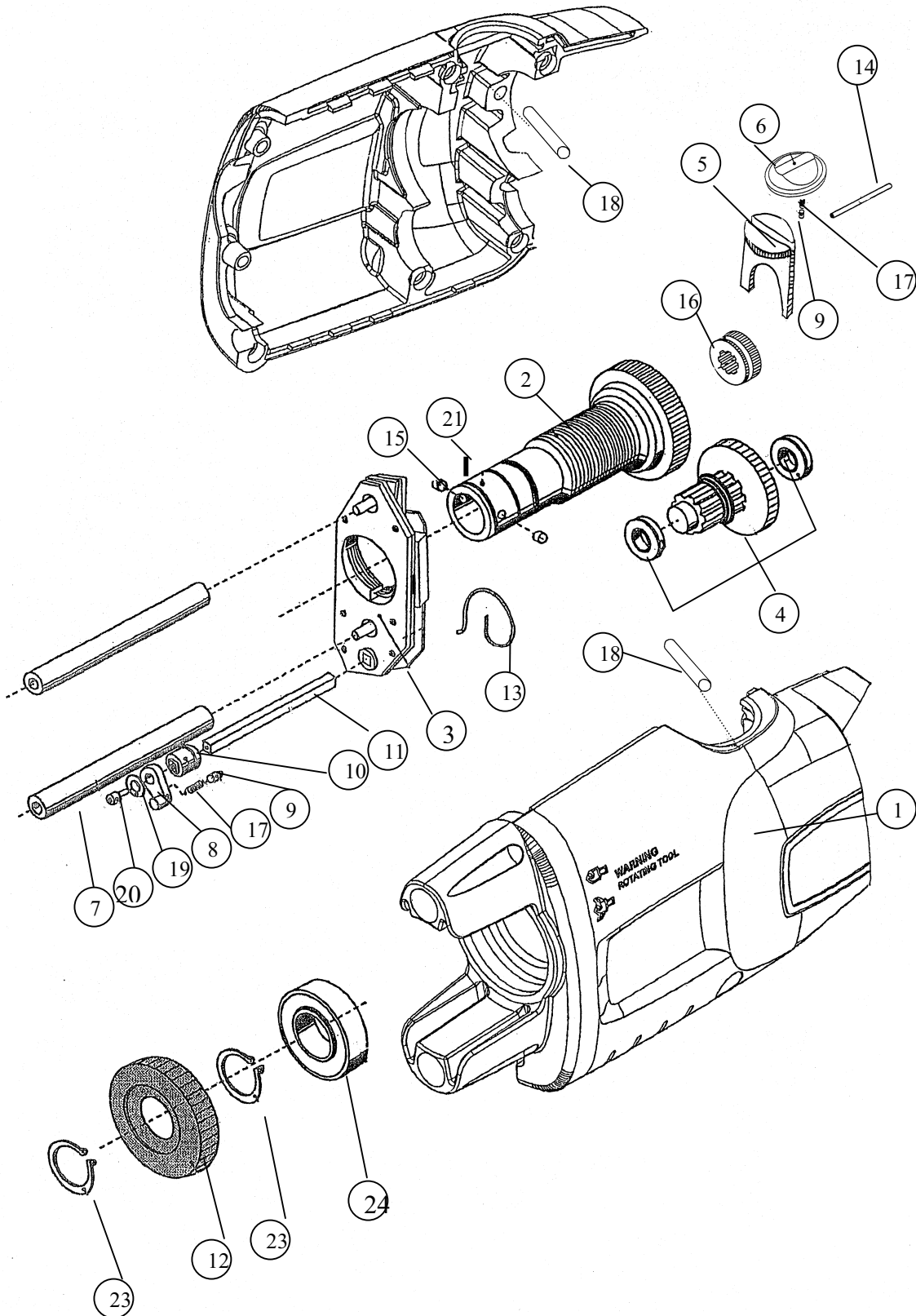

	Part No.	Complete Assembly	
	5330154	T-60 Tee Forming Unit	

Item	Part No.	Description	Qty
1	5330156	Housing	1
2	5330117	Lead Screw	1
3	5330097	Nut Assy Complete	1
4	5540031	Reduction Gear	1
5	3330178	Gear Changer	1
6	5330115	Shift Knob	1
7	4330099	Push Rod	2
8	3330074	Lever	1
9	4540068	Pin	2
10	3330075	Drive Piece	1
11	4540056	Bar	1
12	3300056	Locking Ring	1
13	4300055	Chuck Ring Spring	1
14	4540069	Shaft	1
15	4300054	Chuck Drive Pin	2
16	3540045	Selector Gear	1
17	9026146	Spring	2
18	9018089	Parallel Pin	2
19	9012205	Spring Washer	1
20	9017033	Slot-headed screw	1
21	9018206	Spring Pin 3x8	1
23	9019007	Retaining Ring	2
24	9021006	Groove Ball Bearing 6005 2RS	1

12.3 T-DRILL Head

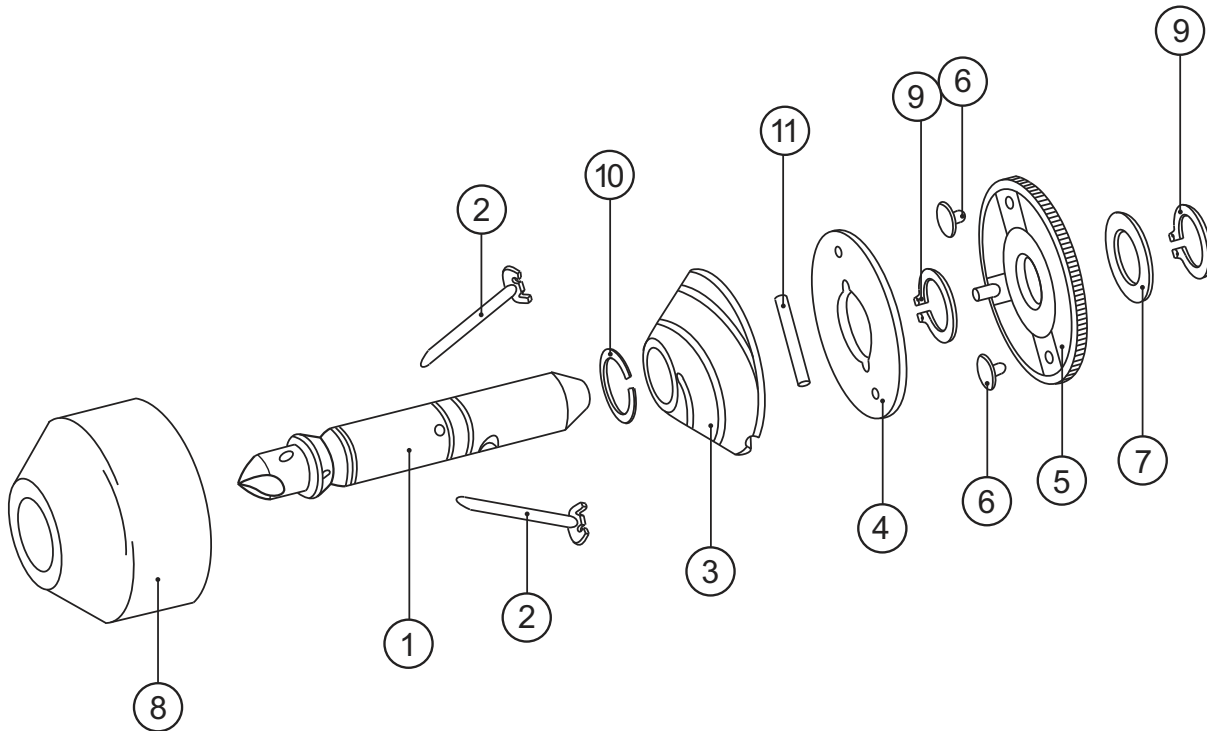

Tea Size \varnothing mm	10	12	15	18	22	28	35	42	54
Nominal Tee Size \varnothing inch	1/4	3/8	1/2	5/8	3/4	1	1 1/4	1 1/2	2
Order No.	5310399	5310400	5310401	5310402	5310403	5310404	5310411	5310412	5310413

Item	Description	Qty	Part No.								
1	Drill Core	1	2310140	2310150	2310160	2310170	2310180	2310210	4310221	4050253	2050254
2	Forming Pin	2	3310240	3310245	3310250	3310250	4310466	4310467	3430033	3430033	3430034
3	Cone	1	2310283	2310283	2310283	2310283	2310283	2310283	2310451	2310451	2310451
4	Adjustment Plate	1	3310293	3310293	3310297	3310310	3310304	3310304	3310304	3050151	3050151
5	Cover Plate Assembl	1	4310323	4310329	4310335	4310341	4310347	4310359	4310362	4310364	4310365
6	Screw	2	4310372	4310372	4310372	4310372	4310372	4310372	4310372	4310372	4310372
7	Spring	1	4310376	4310376	4310376	4310376	4310376	4310376	4310376	4310376	4310376
8	Conical Cover	1	3310380	3310380	3310380	3310380	3310389	3310389	3050149	3050149	3050149
9	Circlip	2	9019003	9019003	9019003	9019003	9019003	9019003	9019003	9019003	9019003
10	Circlip	1	9019201	9019201	9019201	9019201	9019201	-	-	-	-
11	Pin	1	9018038	9018038	9018038	9018038	9018038	9018038	9018038	9018038	9018038

12.4 Counterplate 5540085

Item	Part No.	Name	Size/Type	Std./Manuf.	Qty
1	3540011	Counterplate			1
2	3540012	Counter plate mask.			1
3	3540013	Counterplate fem.			1
5	5540201	Chain			1
6	9018038	Parallel pin	Ø3m6x20	DIN 6325	4
7	4540070	Pin			1

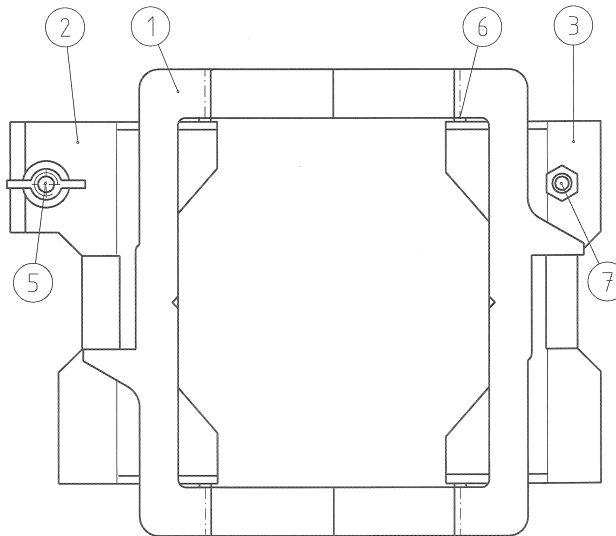

12.4.1 Chain 5540201

Item	Part No.	Name	Size/Type	Std./Manuf.	Qty
1	4050090	Screw			1
2	4540015	Knob			1
3	9013201	Wing nut	M6	DIN 315	1
4	9024117	Coupler link	1/2" Wipperman 332		1
5	9024102	Roller chain	1/2" Wipperman 332 250	DIN 8187	1

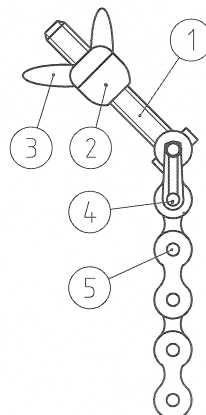

12.5 Optional Equipment

Item	Part No.	Description	Qty
1	5090294	Notcher ND-54	1
2	3310461	Gauge Block	1
3	5540085	Counter Plate	1
5	9010205	Lubricant for Copper 1L-bottle	1

13. Ordering spare parts

When ordering spare parts, please state the following details:

- The type code of the machine
- Manufacturing code of the machine
- The part number
- A description of the part
- The quantity of the parts required

The type code and the manufacturing code of the machine are indicated on the nameplate of the machine. The other information can be found from parts list.

For example:

XX: Assembly name 5XXXXXX 2(4)

Item	Part No.	Designation	Std. /Manuf.	Qty
33	4800220	Left Hand Slide Gib		3
34	9014313	Flat Head Cap Screw M5x8	DIN7991	12
37	3801440	Lever		2
38	4800276	Rod Eye		1
39	4800299	Clamp Ring		4

1

2

3

1. Part number 2. Description 3. Quantity

When ordering spare parts, make a copy of the Service Sheet, fill it out and fax or mail it.

To proceeding this way you will prevent misunderstandings and you make sure to receive the correct spare parts and a prompt service.



Service Sheet

Copy this form first! Fill it out with care. Then Fax or Mail it to your T-Drill representative.

CUSTOMER		Purchase Order _____
Name _____		
Company _____		
Address _____		
City _____	Postal _____	
Country _____	Phone _____	

MACHINE INFORMATION	You will find this information from machine plate.
Machine _____	
Serial _____	Type _____

Pos.	Part	Description	Qty Ordere

Date _____

Authorized

T-DRILL REPRESENTAT

--